



GD



GD6 (12)

Gambo > Shank > Tige > Shaft Ø 3,75 mm M6

M6 M8



GD8 (12)

Gambo > Shank > Tige > Shaft Ø 4,50 mm M8

> **Materiale** > **Material** > **Matériel** > **Material**



CHiodo: Acciaio zincato bianco
NAIL: White zinc plated steel
CLOU: Acier zingué blanc
NAGEL: Blau Verzinkter Stahl



Zincatura elettrolitica, min. 5 micron
Electrolytic galvanizing, min. 5 micron
Zingage électrolytique, min. 5 micron
Galvanisch Verzinkung, min. 5 micron

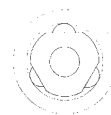

> **Omologazioni** > **Approval** > **Homologation** > **Zulassung**



Chiodatrici omologate CIP > Tools approved CIP
Pisto homologuées CIP > Zugelassener Geräte CIP

> **Caratteristiche** > **Characteristics** > **Caractéristiques** > **Eigenschaften**

- > Fissaggio su calcestruzzo e acciaio. Chiodo con testa filettata ideale per: fissaggi di collari per passatubi e cavi sospesi; fissaggi provvisori vari su calcestruzzo e acciaio. Possibilità assemblaggio con due rondelle in plastica da Ø 12 mm su richiesta.
- > Fixation sur béton et acier. Clou avec tête filettée, idéal pour: fixations de colliers pour gaines et câbles suspendus; fixations provisoires diverses sur béton et acier.
- > Fastener for concrete and steel. Nail with threaded head ideal for: fastening collars for pipe conduits and hanging cables; sundry temporary fastenings on concrete and steel.
- > Befestigung auf Beton und Stahl. Gewindekopfstift, ideal für: Befestigungen von Manschetten für Rohrleitungen und Hängekabel; Diverse provisorische Befestigungen auf Beton und Stahl.

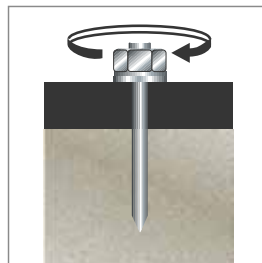
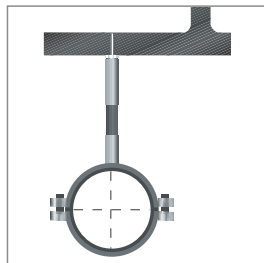

> **Applicazioni** > **Applications** > **Applications** > **Anwendungen**



Edilizia Civile Leggera
Light Civil Construction
Constr. Civile Légère
Leicht Zivilbauwesen



Edilizia Industriale Leggera
Light Industrial Construction
Construction Industriel Légère
Leicht Industriellbauwesen



Settore Elettrico Leggero
Light Electricity Sector
Secteur Electrique Légère
Leicht Elektrischenwesen



Settore Idraulico e Lattineria
Hydraulic and Tiling Sector
Sect. Hydr. et Ferblanterie
Leicht Hydraulikwesen und
Blecharbeiten



Presenza d'acqua
Water in place
Eau sur place
Wasser in Platz



Ambiente Urbano Medio
Inquinamento
Middle Pollution in Town
Moyenne Pollution en Ville
Mittel Stadtverschmutzung



Calcestruzzo C20/25
Concrete C20/25
Beton C20/25
Beton C20/25

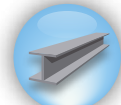

Acciaio
Steel
Acier
Stahl



Legno
Wood
Bois
Holz



> **Dati tecnici** > **Technical data** > **Données techniques** > **Technische Angaben**

L E G E N D	L [mm]	Lunghezza gambo > Shank length > Longueur tige > Shaft Länge
	Ø [mm]	Diametro testa > Head diameter > Diamètre tête > Durchmesser Kopf
	Ø [mm]	Rondella plastica guida > Plastic washer guide > Rondelle plastique guide > Plastik Scheibe
	Ø [mm]	Rondella metallica > Metal washer > Rondelle metallique > Metal Scheibe
	Ø _{est} [mm]	Diametro esterno > External diameter > Diamètre externe > Äussere Durchmesser
	Ø _{int} [mm]	Diametro interno > Internal diameter > Diamètre interne > Innen Durchmesser
	Ø [mm]	Diametro inserto plastico > Plastic component diameter > Diamètre accessoire plastique > Plastikteile Durchmesser
	Ø [mm]	Diametro gabbietta > Ceiling support diameter > Diamètre cage > Käfig Durchmesser
	dxL [mm]	Filettatura diametro x lunghezza > Thread diameter x length > Filet diamètre x longueur > Gewinde Durchmesser x Länge
		Chiodatrice > P.A.Tool > Pisto > Gerät

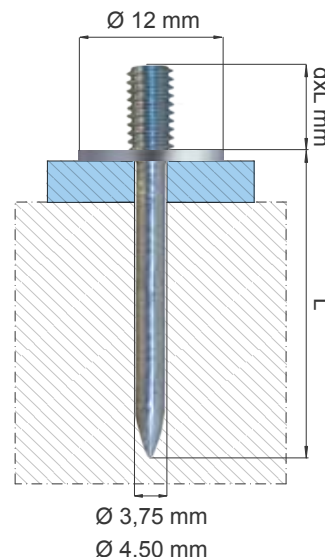

GD6 (12)



Gambo > Shank > Tige > Shaft Ø 3,75 mm M6





CODICE CODE	ARTICOLO ITEM	LUNGHEZZA GAMBO SHANK LENGTH	FILETTO THREAD	RONDELLA PLASTICA PLASTIC WASHER	RONDELLA METALLICA METAL WASHER	FILETTATURA Ø X LUNG. THREAD Ø X LENGTH	CHIODATRICE P.A.TOOL	
	GD6 (12)	L [mm]	Ø [mm]	Ø [mm]	Ø [mm]	dxL [mm]	BOSS	Nr.
266120	GD6 - (12) - 820 	12	M 6	12	12	M6 x 8	4000	100/1000
266125	GD6 - (12) - 825 	17	M 6	12	12	M6 x 8	4000	100/1000
266130	GD6 - (12) - 830	22	M 6	12	12	M6 x 8	4000	100/1000
266145	GD6 - (12) - 845	37	M 6	12	12	M6 x 8	4000	100/1000
266334	GD6 - (12) - 1234	22	M 6	12	12	M6 x 12	4000	100/1000
266339	GD6 - (12) - 1239	27	M 6	12	12	M6 x 12	4000	100/1000
266344	GD6 - (12) - 1244	32	M 6	12	12	M6 x 12	4000	100/1000
266350	GD6 - (12) - 1250	38	M 6	12	12	M6 x 12	4000	100/1000
266542	GD6 - (12) - 2042	22	M 6	12	12	M6 x 20	4000	100/1000
266547	GD6 - (12) - 2047	27	M 6	12	12	M6 x 20	4000	100/1000

GD8 (12)



Gambo > Shank > Tige > Shaft Ø 4,50 mm M8



CODICE CODE	ARTICOLO ITEM	LUNGHEZZA GAMBO SHANK LENGTH	FILETTO THREAD	RONDELLA PLASTICA PLASTIC WASHER	RONDELLA METALLICA METAL WASHER	FILETTATURA Ø X LUNG. THREAD Ø X LENGTH	CHIODATRICE P.A.TOOL	
	GD8 (12)	L [mm]	Ø [mm]	Ø [mm]	Ø [mm]	dxL [mm]	BOSS	Nr.
270514	GD8 - (12) - 1514 	14	M 8	12	12	M8 x 15	4000	100/1000
270527	GD8 - (12) - 1527	27	M 8	12	12	M8 x 15	4000	100/1000
270532	GD8 - (12) - 1532	32	M 8	12	12	M8 x 15	4000	100/1000
270552	GD8 - (12) - 1552	52	M 8	12	12	M8 x 15	4000	100/1000
270627	GD8 - (12) - 2027	27	M 8	12	12	M8 x 20	4000	100/1000
270632	GD8 - (12) - 2032	32	M 8	12	12	M8 x 20	4000	100/1000